

# PHILIPS

FT741 Tuner

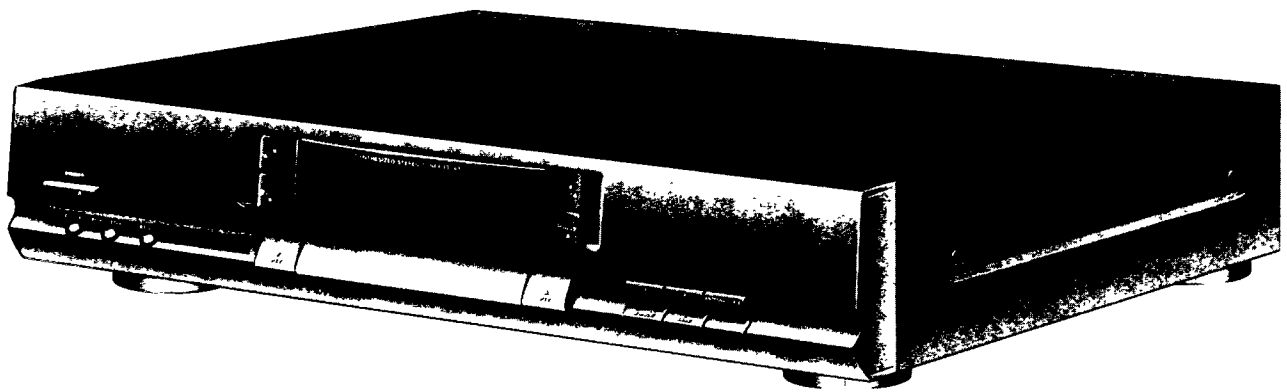

Instructions for use  
Mode d'emploi  
Instrucciones de manejo  
Bedienungsanleitung  
Gebruiksaanwijzing  
Istruzioni per l'uso  
Brugsanvisning  
Bruksanvisning  
Käyttöohje  
Manual de utilização



# PHILIPS

## Important notes for users in the U.K.

### Mains plug

This apparatus is fitted with an approved 13 Amp plug. To change a fuse in this type of plug proceed as follows:

- 1 Remove fuse cover and fuse.
- 2 Fix new fuse which should be a BS1362 5 Amp, A.S.T.A. or BSI approved type.
- 3 Refit the fuse cover.

If the fitted plug is not suitable for your socket outlets, it should be cut off and an appropriate plug fitted in its place. If the mains plug contains a

fuse, this should have a value of 5 Amp. If a plug without a fuse is used, the fuse at the distribution board should not be greater than 5 Amp.

**Note:** *The severed plug must be disposed of to avoid a possible shock hazard should it be inserted into a 13 Amp socket elsewhere.*

### How to connect a plug

The wires in the mains lead are coloured with the following code: blue = neutral (N), brown = live (L). As these colours may not correspond with the colour markings identifying the terminals in your plug, proceed as follows:

- Connect the blue wire to the terminal marked N or coloured black.
- Connect the brown wire to the terminal marked L or coloured red.
- Do not connect either wire to the earth terminal in the plug, marked E (or  $\frac{1}{2}$ ) or coloured green (or green and yellow).

Before replacing the plug cover, make certain that the cord grip is clamped over the sheath of the lead - not simply over the two wires.

### Copyright in the U.K.

Recording and playback of material may require consent. See Copyright Act 1956 and The Performer's Protection Acts 1958 to 1972.

## Italia

### DICHIARAZIONE DI CONFORMITA'

Si dichiara che il sintonizzatore mod. FT 741 Philips risponde alle prescrizioni dell'art. 2 comma 1 del D. M. 28 Agosto 1995 n. 548.

Fatto a Eindhoven, il 11/09/1996

Philips Sound & Vision  
Philips, Glaslaan 2, SFF 10  
5616 JB Eindhoven, The Netherlands

## Norge

Typeskilt finnes på apparatens underside.

**Observer:** Nettbryteren er sekundert innkopleet. Den innebygde nettdelen er derfor ikke frakopleet nettet så lenge apparatet er tilsluttet nettkontaktten.

For å redusere faren for brann eller elektrisk støt, skal apparatet ikke utsettes for regn eller fuktighet.

## Deutschland

Hiermit wird bescheinigt, daß dieses Gerät in Übereinstimmung mit den Bestimmungen der Amtsblattverfügung 1046/1984 funktentstört ist.

Der Deutschen Bundespost wurde das Inverkehrbringen dieses Gerätes angezeigt und die Berechtigung zur Überprüfung der Serie auf Einhaltung der Bestimmungen eingeräumt.

|                   |                                                                                                                     |                   |
|-------------------|---------------------------------------------------------------------------------------------------------------------|-------------------|
| <b>English</b>    | Installation .....4<br>Operating elements.....5<br>Operation.....6-10<br>Important information .....11              | <b>English</b>    |
| <b>Français</b>   | Installation .....12<br>Eléments de commande.....13<br>Fonctionnement.....14-18<br>Ce que vous devez savoir .....19 | <b>Français</b>   |
| <b>Español</b>    | Instalación .....20<br>Elementos de mando .....21<br>Manejo .....22-26<br>Particularidades .....27                  | <b>Español</b>    |
| <b>Deutsch</b>    | Installation .....28<br>Bedienelemente .....29<br>Bedienung.....30-34<br>Wissenswertes .....35                      | <b>Deutsch</b>    |
| <b>Nederlands</b> | Installatie .....36<br>Bedieningstoetsen .....37<br>Bediening.....38-42<br>Belangrijke informatie.....43            | <b>Nederlands</b> |
| <b>Italiano</b>   | Installazione .....44<br>Elementi di comando .....45<br>Impiego.....46-50<br>Informazioni generali .....51          | <b>Italiano</b>   |
| <b>Svenska</b>    | Installation .....52<br>Kontroller .....53<br>Användning.....54-58<br>Värt att veta .....59                         | <b>Svenska</b>    |
| <b>Dansk</b>      | Opstilling.....60<br>Betjeningslementer .....61<br>Betjening .....62-66<br>Værd at vide .....67                     | <b>Dansk</b>      |
| <b>Suomi</b>      | Asennus.....68<br>Säätimet.....69<br>Käyttö .....70-74<br>Hyvä tietää .....75                                       | <b>Suomi</b>      |
| <b>Português</b>  | Instalação .....76<br>Elementos de operação .....77<br>Manejo .....78-82<br>Factos interessantes .....83            | <b>Português</b>  |

# INSTALLATION

English

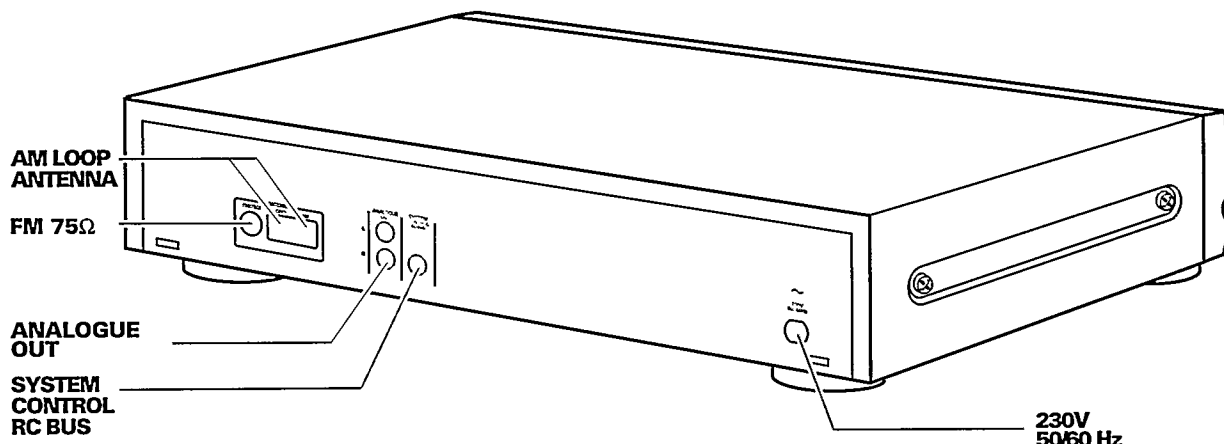

## Setting up

- If you want to set up your tuner on a shelf, in a cabinet or any other type of enclosure, always ensure that sufficient ventilation is available. An open space of at least 3 cm at the sides and the top, and 5 cm at the back of your system is required.
- Place the power supply cable as far as possible from the sound signal lines in order to avoid disturbing signal interference.
- When making connections, always note the identification markings on the cables and sockets, as well as those on the back of the unit, in order to avoid improper connections. Improper connections can considerably impair sound quality.

## Power supply connection

- Only connect the unit to a 230V~, 50/60 Hz a.c. power source.
- If you want to switch your unit on and off via an amplifier from this series, or with the system remote control, connect the mains plug of the tuner to one of the **AC OUTLETS** of your amplifier. To use this capability, ensure that the power switch of the tuner is switched to the **ON** position. The amplifier's power switch can then be used as the main switch for all the units.
- Always ensure that the voltage indicated on the unit's backside agrees with your local power supply. If this is not the case, consult your dealer or customer service center.

## Connection to the amplifier

Your tuner should be connected to the corresponding input sockets on the amplifier.

- Connect the **ANALOGUE OUT** sockets to the **TUNER** input sockets on the amplifier. When connecting the cables, ensure the proper arrangement of the stereo channels:  
**L** = left channel (white).  
**R** = right channel (red).

## RC-BUS connection

If you would like to operate the unit via the infrared remote control supplied with the amplifier of this series, the system bus line (RC-BUS) must be connected between the tuner and the amplifier. The tuner must still be connected to the input socket TUNER of the amplifier.

- Connect the **RC-BUS** socket to one of the RC-BUS sockets of your amplifier of this series.

## Antenna connection

Only a good antenna system (broadband cable connection to your own antenna system, or a common house antenna system) can guarantee optimum reception quality, especially for FM stereo broadcasts.

### FM 75 Ω

- The **FM 75 Ω** socket is used for connection to the Community or Cable Antenna System or to a roof-mounted FM antenna with an impedance of 75 Ohm.
- If none of these are available, you may use the cast (wire) antenna supplied for nearby station (reception could be poor). You should not, however, change the length of the cast antenna.

### AM ANTENNA

- For AM reception, connect the supplied wires to the **GND/AM ANTENNA** terminals and position the antenna for best reception.
- The elevated antenna as well as earth can also be connected to these sockets in place of the frame antenna.

*Note: do not place the AM loop antenna on the unit, as this unit employs a computing device which could cause interference.*

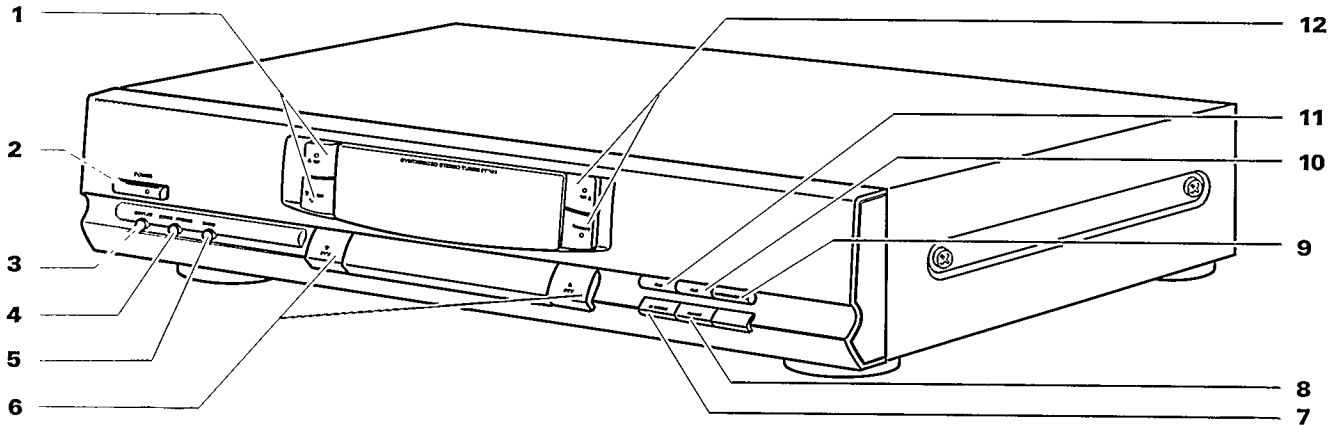

## Front of the tuner

- 1 TUNING ▲ ▼**.....You use these buttons to start the station search (AUTO TUNING) or to advance the frequency step by step (MANUAL TUNING). If you keep the button depressed, station search is accelerated.
- 2 POWER**.....This button is used for switching the tuner on and off.
- 3 DISPLAY** .....You can use this button to switch the display on and off.
- 4 MONO/STEREO**..You use this button for selecting mono reception if, for example, stereo reception exhibits too much disturbing noise. This simultaneously switches off the MUTING function.
- 5 BAND** .....This button is used to switch to the FM, MW and LW bands.
- 6 PTY ▲ ▼**.....These buttons are used to select the programme type.
- 7 D. MODE** .....This button is used for switching the display between the station name (RDS), or another name you assign, RADIOTEXT, RDS time and station frequency.
- 8 NAME**.....This button is used for selecting the station name input mode.
- 9 ANTENNA/CABLE** ...This button is used to switch on the FM antenna attenuator for reducing radio disturbance if your tuner is connected to broadband cable and the reception signal is too strong.
- 10 CLR**.....This button is used to delete individual memory locations or, if desired, the entire memory contents (by keeping the button depressed for longer than 10 seconds).
- 11 PRG**.....This button stores a set station at the lowest respective memory location.  
When pressing this button longer, the AUTO STORE function will be started.
- 12 PRESET STATION ▲ ▼** ...These buttons are used to scroll through the station memory in the direction indicated by the arrows.

## Display

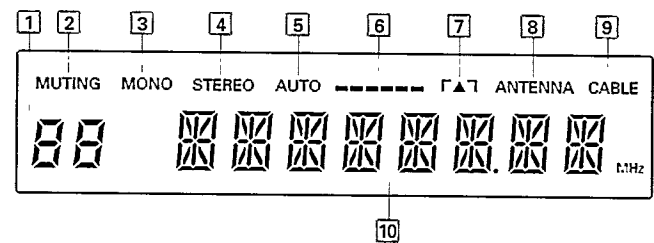

- 1 STATION NUMBER seven-segment display**  
This shows the number of the selected memory location (1 to 59) as either one or two digits.
- 2 MUTING** – This indicates that the MUTING function is active.
- 3 MONO** – This comes on if the MONO function is activated.
- 4 STEREO** – This indicates that the tuner is receiving FM stereo broadcasts.
- 5 AUTO** – This indicates that the AUTO TUNING function is active
- 6 Signal strength** – The more dashes you can see, the stronger the reception of the station you have tuned to.
- 7 ▲** – If the unit is optimally tuned to a station, the triangle lights up, indicating the exact station tuning.
- 8 ANTENNA** – comes on when the antenna attenuator is not switched on.
- 9 CABLE** – comes on during broadband cable reception if the antenna attenuator is switched on with the **ANTENNA/CABLE** button.
- 10 14-segment display** – for frequencies in MHz (FM) or kHz (AM, LW), (RDS) station name, radio text, RDS time, names you have assigned or the selected programme type.

## Switching the display off

The display is automatically switched on whenever the unit is activated.

- Press the **DISPLAY** button to switch the display off. Pressing any button will cause the display to come on again for approx. 5 seconds. The next time you activate the unit, or if you press the **DISPLAY** button again, the display will remain illuminated.

# OPERATION

## Switching on and off

- When you want to switch your tuner on, press the **POWER** button. The LED in the middle of the button indicates that the unit is on.  
button depressed: POWER ON  
button not depressed: POWER OFF
- When you want to switch the unit off, simply press the **POWER** button again.  
→The first time you switch your unit on, it automatically switches to 'FM', and the display indicates 87,50 MHz and MUTING. STEREO is also selected.
- If the mains plug of your TUNER is connected to one of the AC OUTLETS on the amplifier, the **POWER** button of the amplifier serves as the central switch for all units connected to the AC OUTLETS.  
To use this capability, ensure that the **POWER** switch of the tuner is switched to the on position (depressed).  
→Your unit is provided with the function 'LAST STATION MEMORY', which means that the station that was playing when the set was switched off will be selected again when the tuner is switched back on.

## Selecting the wave band

- Select the desired wave band (FM, MW or LW) by pressing the **BAND** button. Pressing this button switches to the next wave band in the following order: FM - MW - LW - FM.  
→The display shows the selected band.

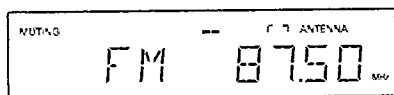

## Adapting the antenna

If you receive broadcasts via broad band cable of a public or private cable service, there may be high signal inputs at your antenna terminal, which may in turn cause reception disturbances.

- If this is the case, press the **ANTENNA/CABLE** button to switch on the input attenuator 'CABLE' appears on the display. This reduces the antenna input sensitivity, thus reducing disturbances. This setting is automatically stored.

## RDS Radio Data System

Your tuner is an RDS tuner.

RDS (Radio Data System) stands for a new generation of radios that provides the listener/user with more comfort and better reception in the short term, but also opens up completely new information options for the future. RDS-equipped receivers identify the tuned station (if it transmits 'RDS signals') and indicate the name of the programme in the 8-place display (e.g. BAYERN 3, SDR 3). If you are tuned to an RDS station, the name of the station will be indicated after a short time.  
For more information, please see page 9.

## FM reception MONO/STEREO

Normally, your unit is in stereo reception mode, which means that as soon as a stereo signal of sufficient strength is detected, 'STEREO' appears in the display. If stereo reception is disturbed, 'STEREO' disappears. In this way, disturbing background noise is suppressed.

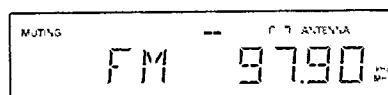

If noise-free stereo reception is not possible, you can switch your unit to MONO reception.

- In this case, press **MONO/STEREO**.  
→MUTING will disappear from the display and MONO will appear. The MUTING function is always switched off for MONO reception, allowing the unit to receive even very weak broadcast signals.

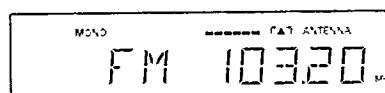

## Automatic station search

- To activate automatic station search (AUTO TUNING), press **TUNING ▲** or **▼** until the frequency display begins 'to run'; then release the button.
  - 'AUTO' appears in the display, and disappears at the conclusion of the automatic tuning function.

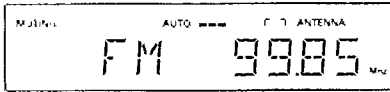

- The search stops as soon as a station with sufficient reception quality is found and tuned to precisely. A triangle in the display lights up.

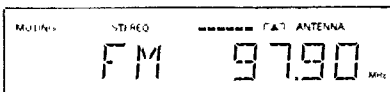

- Every time you begin a search, the unit automatically switches to STEREO.
- A bar graph in the display indicates the field strength: the more illuminated dashes you see, the stronger the reception.
- The frequency of the received station is indicated in kHz (MW/LW) or MHz (FM).
- If the search stops, the 'AUTO COMPARE' function first verifies whether the station which has been found is already stored in the station memory. If this is the case, the memory location of the station is displayed, as well as the name of the station, if it already exists.
- Stations which are received with a weak field strength may be skipped. These can be tuned to manually.
- If desired, you can also interrupt the search by pressing **TUNING ▲▼**.

## Manual station search (manual tuning)

- Briefly press the **TUNING ▲** or **▼** button to tune in the corresponding direction in individual steps (FM: 25kHz; MW/LW: 1 kHz).
- If you keep the button depressed, you can rapidly scan large frequency ranges. When you release the button, AUTO TUNING is automatically switched to. Muting is active during AUTO TUNING.
- If you briefly press one of the **TUNING ▲▼** buttons, manual tuning is automatically switched to, and the symbol "AUTO" disappears.
  - Just as with automatic tuning, the illuminated triangle and the number of illuminated dashes indicate the reception quality.

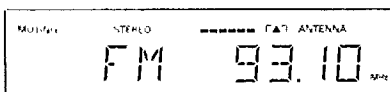

- The 'AUTO COMPARE' function also verifies whether the found frequency is already stored.

## Station memory

59 memory locations are available for storing stations.

- Tune to the station you want to store with the station search function or manually.

- Press **PRG**.

- The station is stored at the next available memory location.

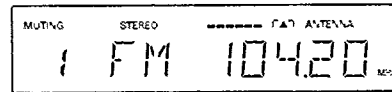

- The tuner software first checks the station memory for available memory locations. If all the locations are occupied, MEM FULL appears on the display for approx. 1.5 seconds.
- Assigning a station frequency to two different memory locations is not possible. The selected station is stored at the lowest available memory location, meaning that you need not enter a number for memory locations.
- Every time the settings STEREO/MONO and ANTENNA/CABLE are changed, they are automatically stored.

## Storing stations

- If you want to store a station, press **PRG**.
  - The first station which is stored is assigned to memory location 1, the second station to memory location 2 and so on.
- If you want to move a stored station to another memory location, press **PRG**.
  - The station is always assigned to the first available memory location.
- Pressing the button again assigns a station to the next available memory location.

### Example:

You want to move your favourite station from memory location '6' to memory location '1'.

- Select memory location '1'.

- Press **CLR** once.

- This deletes, or clears, memory location '1'.

You can also press **PRG** to move the station on location '1' to the next available free memory location.

- Now select position '6', your favourite station, and then press **PRG**. Your station is now stored on memory location '1'.

# OPERATION

## AUTO STORE function

This tuner is equipped with a comfortable way to store all stations automatically.

- 1 Select the FM waveband.
- 2 Press and hold down **PRG** until AS appears on the display.
  - The AUTO STORE function is started.
  - The tuner will start searching from the actual frequency and stores, first of all, all RDS stations that are not yet stored in the memory.
  - Then it searches for the strongest non-RDS station and finally the weak ones.
  - This function ensures you that all stations with an acceptable reception quality are stored in your station memory.
- 3 You can interrupt the AUTO STORE function by pressing **PRG** again.

## Calling up a stored station

- When you want to call up a stored station, press **PRESET STATION ▲▼**. The stations are called up in ascending or descending order.

**Stations can also be selected via the system remote control:**

- 1 Select the TUNER input by pressing the **TUNER** button
- 2 Press either the **TUNER PRESET STATION ▲▼** button, or directly enter the memory location number with the numeric buttons 0..9.
  - The display shows the selected memory location number in the upper left, and the unit switches to this memory location.
- 3 For one-place memory location numbers, press the corresponding button only briefly.

For two-place number, first press the first number longer until this number jumps to the left side of the display: /-.
- 4 Then enter the second number.
  - If you have selected a memory location to which no station has been assigned (yet), 'FREE' appears briefly in the display. The unit then switches to the most previously set memory location.

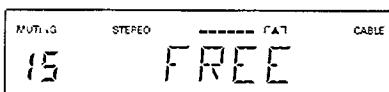

- The display shows the selected memory location number in the upper left, and the unit switches to this memory location.

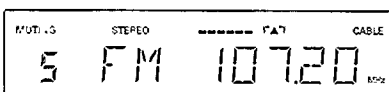

## Deleting a memory location

- 1 If you want to delete a memory location to which a station is assigned, first call up its number.
    - Press **PRESET STATION ▲▼** until you reach the station you want to delete. You may also use the **PRESET STATION ▲▼** or numeric buttons on the system remote control.
  - 2 Press **CLR**.
    - The memory location is deleted, and the memory location number does not light up on the display anymore.
- Hold **CLR** down for 5 seconds if you want to delete all the memory locations, for example after you move to another location.
    - 'ERASE ?' appears briefly on the display.
  - Keep the button depressed for an additional 5 seconds until the display shows '87,5 MHz'.
    - The station memory is deleted.
  - If you now press one of the **PRESET STATION ▲▼** buttons, 'FREE' is shown on the display.
  - If you release the **CLR** button before these 5 seconds have elapsed, the erase function is not carried out.

## 'LAST STATION MEMORY'

LAST STATION MEMORY means that the unit 'remembers' the last station that was tuned to. This function ensures that the station which was selected before the tuner was switched off is automatically selected again when your tuner is switched back on.



## RDS Radio Data System

Your unit is capable of receiving and evaluating RDS information which is broadcast along with the normal broadcast signal. The channel name is displayed and automatically stored in the unit's memory, overwriting names previously stored.

### RDS TIME

Some RDS stations broadcast the 'RDS-TIME' information.

- You can call up the time display by pressing the **D. MODE** button until the 'RDS-TIME' display appears.
  - The time display is updated every minute. The accuracy of the time depends on the broadcasted information.

### RADIOTEXT

Some RDS stations broadcast RADIOTEXT, which is additional information on the station and programme being broadcast. RADIOTEXT information appears as "running" text in the display. RADIOTEXT is transmitted character-by-character by the radio station. As a result of that it may take some time until the entire text has been completely received.

- RADIOTEXT is called up by continuously pressing the **D. MODE** button until the running text of the RADIOTEXT signal can be seen.
  - If a station does not broadcast RADIOTEXT, the unit switches automatically to the frequency indication.

### Switching displays

- Pressing **D. MODE** briefly switches the display (when available) between station name (RDS or one you have entered), RDS-TIME, RADIOTEXT (with RDS stations), and frequency.
  - When the station name is displayed, only the memory location number is displayed to the left of the name.

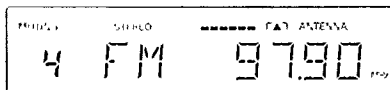
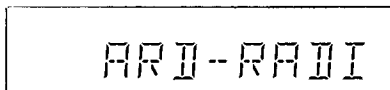
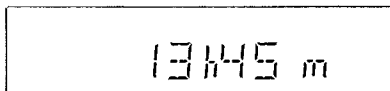
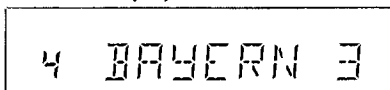

### Programme type (PTY)

RDS allows you to select FM stations according to programme type. There are 16 programme categories.

- By using the **PTY ▲▼** buttons (on the tuner or on the system remote control), you can call up the programme types one after another.
  - The display briefly shows the programme type and then the name of the stations that broadcast this programme type.
  - If there are no stations broadcasting a given programme type, the display briefly shows: 'NONE'.

### What is meant by programme types?

**NEWS** = News service

Programmes that usually give brief reports on current events and statements that are of public interest. Also: weather and traffic reports.

**AFFAIRS** = Politics and current events

Programmes that supplement or give more extensive information on the news, e.g. reports and commentary, news magazine. These programmes also offer detailed accounts on related issues, e.g. documentation and discussions. Also: broadcasts of political and similar events.

**INFO** = Special informative reports

Programmes that offer helpful information, e.g. consumer magazine, health tips, travel tips, special weather service. In addition, there are also programmes for individual target groups, e.g. for farmers, children, foreign employees.

**SPORT** = Sports

All types of sports programmes.

**EDUCATE** = Learning and continuation of education

Educational programmes for those who wish to gain or further their knowledge of different fields; e.g. schools' radio, educational radio broadcasts, foreign language courses.

**DRAMA** = Radio plays, literature

All types of radio plays, e.g. radio thrillers and science fiction programmes; readings from literary works.

**CULTURE** = Culture, church and society

Programmes that offer reports, commentaries or evaluations on topics from the above-mentioned areas; e.g. discussions on theater, films and books, literary radio series, reports on the school and educational system, church radio; also prayers and church services.

**SCIENCE**

Programmes that deal with methods and findings from the world of science, as well as with issues from the field of technology.

**VARIETY**

Programmes that mostly offer light entertainment, e.g. talk shows, quiz shows and guessing games, cabaret shows, sketches, chat shows etc., often featuring music.

**POP M.** = Pop music

Programmes with popular and modern hits from home and abroad.

**ROCK M.** = Rock music

Programmes with international music of the younger generation, often with a heavy emphasis on rhythm.

**EASY M.** = Light music

Programmes with light music of all types, e.g. folk music, dance music, musicals and operettes.

**LIGHT-M.** = Light classical music

Programmes with popular classical music; music, often abbreviated works of excerpts of works, e.g. overtures, arias, etc.

**CLASSICS** = Serious classical music

Programmes with more serious works, e.g. symphonies, chamber music, full-length operas.

**MUSIC** = Special music programmes

Music programmes that cannot be assigned to one of the above mentioned programme types, e.g. folklore, jazz, experimental music.

# OPERATION

English

## Assigning station names

Stations which do not transmit the RDS code can be assigned any name of your choice.

- 1 Press **NAME**.
- 2 With **TUNING ▲▼**, you can move the cursor in the desired direction. You can enter up to eight characters.
- 3 With **PRESET STATION ▲▼**, you can move forward and backward through the alphabet, the numbers 0-9 and to the space key.

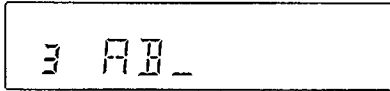

- 4 When you are ready to conclude an input and exit the input mode to store a name, press **NAME** or **PRG**.

*Note: If you attempt to assign a name to a station which transmits the RDS code, RDS-DATA appears in the display, indicating that a name cannot be assigned.*

## Deleting a name

- If you press **CLR** when the input mode is selected, the previous name is deleted and the cursor jumps to the first (left) position.



## Trouble shooting

The following checklist will help you to correct most of the problems that can occur with your unit. If the following list does not help, please consult your HiFi dealer.

Before you go through the following list, verify the following points:  
 ☞ The mains cable, the antenna cable and the cables to the amplifier must be securely connected.

| Problem                            | Cause (and correction)                                                                                                                                                                                                                 |
|------------------------------------|----------------------------------------------------------------------------------------------------------------------------------------------------------------------------------------------------------------------------------------|
| <b>The unit does not function.</b> | If the unit 'hangs' and you get no response whatsoever, this could be due to electrostatic discharge phenomena.<br>Switch the unit OFF with the POWER button, and then on again, or pull the plug from the mains socket and re-insert. |
| <b>No sound.</b>                   | Due to bad stereo reception the muting function is active.<br>Press the MONO/STEREO button to select mono reception or adjust the frequency.                                                                                           |
| <b>Strong hum or hiss.</b>         | Adjust the aerial.<br>Station signal is too weak. (Connect to an outside aerial for improved reception).                                                                                                                               |

## Caring for the unit

Wipe the housing clean with a soft, dry and antistatic cloth. Polishing and cleaning agents can damage the surface of the housing.

## Environmental information

All redundant packing material has been omitted. We have done our utmost to make the packaging easy separable into three mono materials: cardboard (box), polystyrene foam (buffer) and polyethylene (bags, protective foam sheet).

*Your set consists of material which can be recycled if disassembled by a specialized company. Please observe the local regulations regarding the disposal of packing materials, exhausted batteries and old equipment.*

**The type plate is located at the rear of the system.  
 This set complies with the radio interference requirements of the European Union.**

## Technical data

### FM range

**Reception range** .....87,5 ... 108,0 MHz  
 (50 kHz for station, 25 kHz for manual tuning)

### Sensitivity

(S+N) / N=26 dB, mono .....1,0 µV  
 (S+N) / N=46 dB, stereo .....35µV

### Dynamic separation

(mono, stereo, ± 300 kHz) .....≥ 60dB

**Distortion factor mono/stereo** .....≤0,2/0,4%

### Signal-to-noise ratio

(IEC curve A effective value).....Mono ≥ 74 dB; Stereo ≥ 70 dB

**Output resistance**.....1,7 kOhm

**Output voltage** .....650 mV

**Frequency range** .....10 ... 15 000 Hz

### AM range

**Reception range** .....MW: 528 ... 1605 kHz (manual tuning)  
 531 ... 1602 kHz (automatic tuning)  
 LW: 153 ... 281 kHz

**Supply voltage, mains frequency**.....230 V ~, 50/60 Hz

**Power consumption**.....8 W

*All rights reserved*

# Meet Philips at the Internet

<http://www.philips.com>

English

Français

Español

Deutsch

Nederlands

Italiano

Svenska

Dansk

Suomi

Português

